

WMK053N10HGS

100V N-Channel Enhancement Mode Power MOSFET

Description

WMK053N10HGS uses Wayon's advanced power trench MOSFET technology that has been especially tailored to minimize the on-state resistance and yet maintain superior switching performance. This device is well suited for high efficiency fast switching applications.

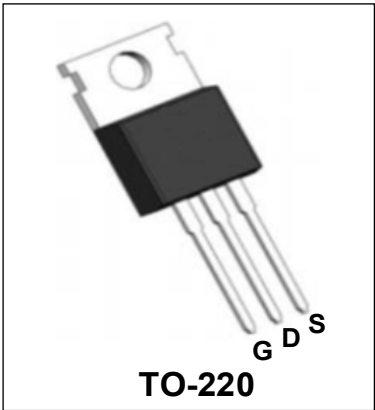

Features

- $V_{DS} = 100V$, $I_D = 123A$
- $R_{DS(on)} < 5.5m\Omega @ V_{GS} = 10V$
- Green Device Available
- Low Gate Charge
- 100% EAS Guaranteed

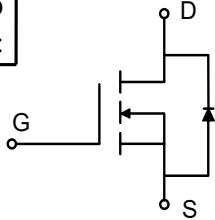

Applications

- Power Management Switches
- DC/DC Converter
- LED Backlighting

Absolute Maximum Ratings ($T_A = 25^\circ C$, unless otherwise noted)

Parameter	Symbol	Value	Unit
Drain-Source Voltage	V_{DS}	100	V
Gate-Source Voltage	V_{GS}	± 20	V
Continuous Drain Current	I_D	$T_C=25^\circ C$	123
		$T_C=100^\circ C$	78
Pulsed Drain Current ¹	I_{DM}	480	A
Single Pulse Avalanche Energy ²	EAS	245	mJ
Total Power Dissipation	P_D	197.4	W
Operating Junction and Storage Temperature Range	T_J, T_{STG}	-55 to 175	$^\circ C$

Thermal Characteristics

Parameter	Symbol	Value	Unit
Thermal Resistance from Junction-to-Ambient ³	$R_{\theta JA}$	56	$^\circ C/W$
Thermal Resistance from Junction-to-Case	$R_{\theta JC}$	0.76	$^\circ C/W$

Electrical Characteristics (T_J = 25°C, unless otherwise noted)

Parameter	Symbol	Test Conditions	Min.	Typ.	Max.	Unit
Static Characteristics						
Drain-Source Breakdown Voltage	V_{(BR)DSS}	V _{GS} = 0V, I _D = 250μA	100	-	-	V
Gate-body Leakage current	I_{GSS}	V _{DS} = 0V, V _{GS} = ±20V	-	-	±100	nA
Zero Gate Voltage Drain Current	T _J =25°C	V _{DS} =100V, V _{GS} = 0V	-	-	1	μA
	T _J =100°C		-	-	100	
Gate-Threshold Voltage	V_{GS(th)}	V _{DS} = V _{GS} , I _D = 250μA	2	3	4	V
Drain-Source on-Resistance ⁴	R_{DS(on)}	V _{GS} = 10V, I _D = 20A	-	4.5	5.5	mΩ
Forward Transconductance ⁴	g_{fs}	V _{DS} =10V, I _D =20A	-	59	-	S
Dynamic Characteristics⁵						
Input Capacitance	C_{iss}	V _{DS} = 50V, V _{GS} = 0V, f = 1MHz	-	4903	-	pF
Output Capacitance	C_{oss}		-	662	-	
Reverse Transfer Capacitance	C_{rss}		-	25	-	
Gate Resistance	R_g	f = 1MHz	-	1.4	-	Ω
Switching Characteristics⁵						
Total Gate Charge	Q_g	V _{GS} = 10V, V _{DS} = 50V, I _D =20A	-	82.5	-	nC
Gate-Source Charge	Q_{gs}		-	24	-	
Gate-Drain Charge	Q_{gd}		-	23.5	-	
Turn-on Delay Time	t_{d(on)}	V _{GS} = 10V, V _{DD} = 50V, R _G = 3Ω, I _D = 20A	-	15.8	-	ns
Rise Time	t_r		-	12.8	-	
Turn-off Delay Time	t_{d(off)}		-	34	-	
Fall Time	t_f		-	6.8	-	
Body Diode Reverse Recovery Time	t_{rr}	I _F = 20A, dI/dt=100A/μs	-	56	-	ns
Body Diode Reverse Recovery Charge	Q_{rr}		-	102	-	nC
Drain-Source Body Diode Characteristics						
Diode Forward Voltage ⁴	V_{SD}	I _S = 20A, V _{GS} = 0V	-	-	1.2	V
Continuous Source Current	T _C =25°C	I_S	-	-	123	A

Notes:

1. Repetitive rating, pulse width limited by junction temperature T_{J(MAX)}=175°C.
2. The EAS data shows Max. rating . The test condition is V_{DD}=25V, V_{GS}=10V, L=0.4mH, I_{AS}=35A.
3. The data tested by surface mounted on a 1 inch² FR-4 board with 2OZ copper, The value in any given application depends on the user's specific board design.
4. The data tested by pulsed , pulse width ≤ 300us , duty cycle ≤ 2%.
5. This value is guaranteed by design hence it is not included in the production test.

Typical Characteristics

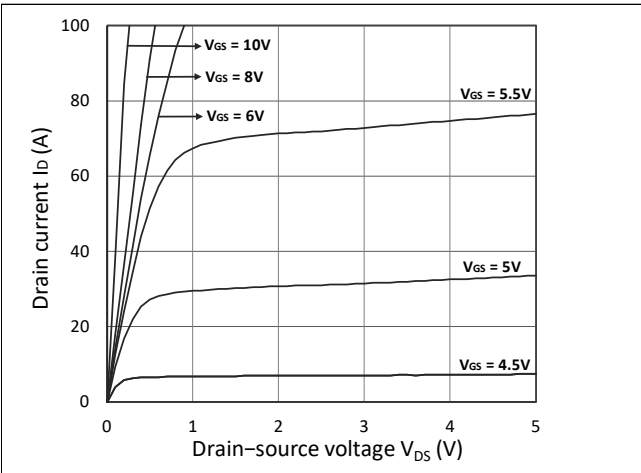

Figure 1. Output Characteristics

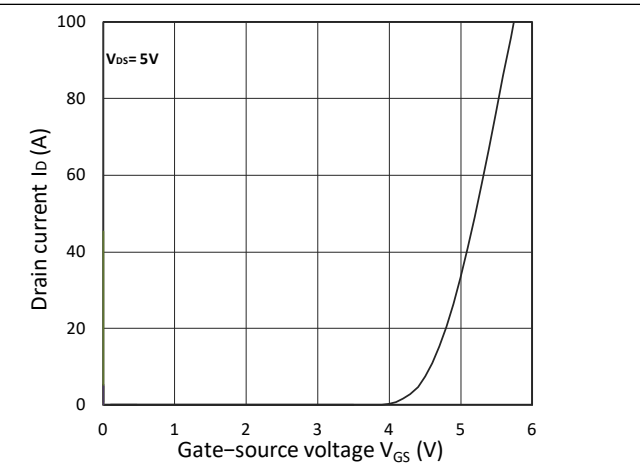

Figure 2. Transfer Characteristics

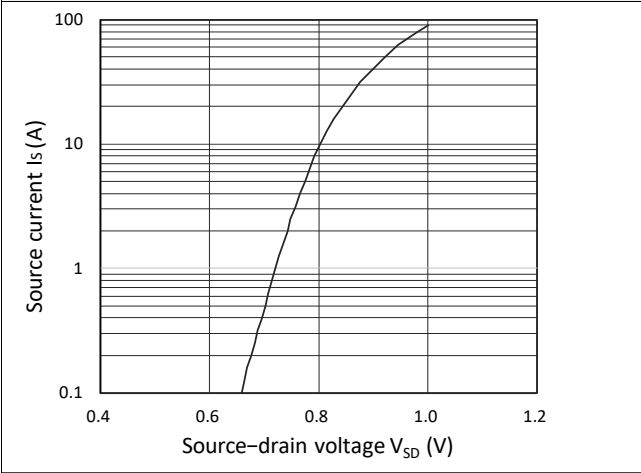

Figure 3. Forward Characteristics of Reverse

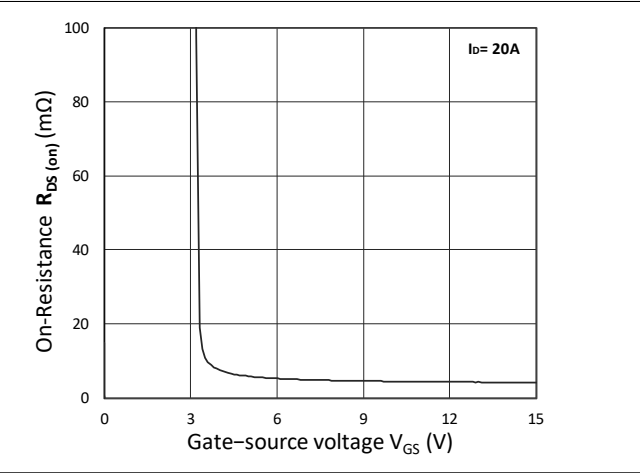

Figure 4. $R_{DS(on)}$ vs. V_{GS}

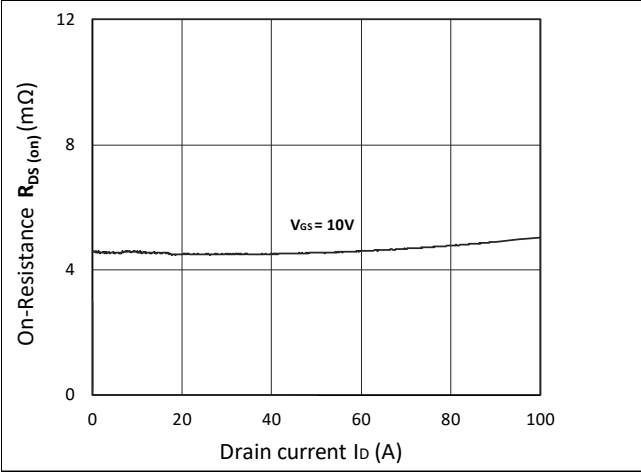

Figure 5. $R_{DS(on)}$ vs. I_D

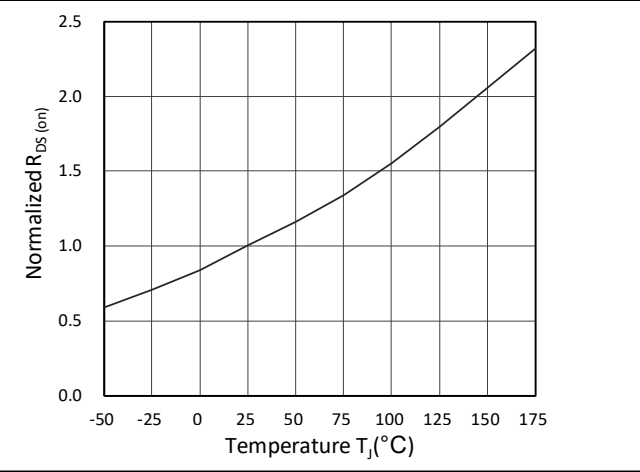

Figure 6. Normalized $R_{DS(on)}$ vs. Temperature

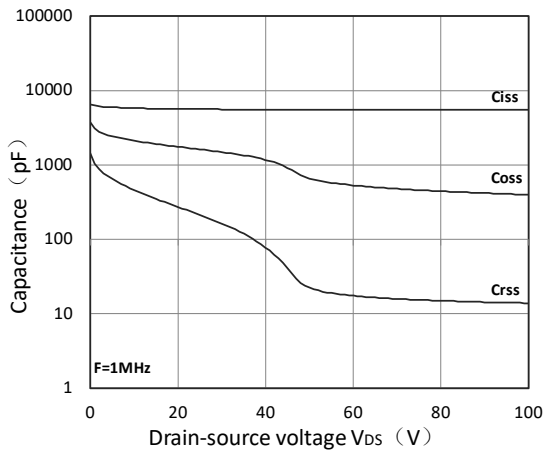

Figure 7. Capacitance Characteristics

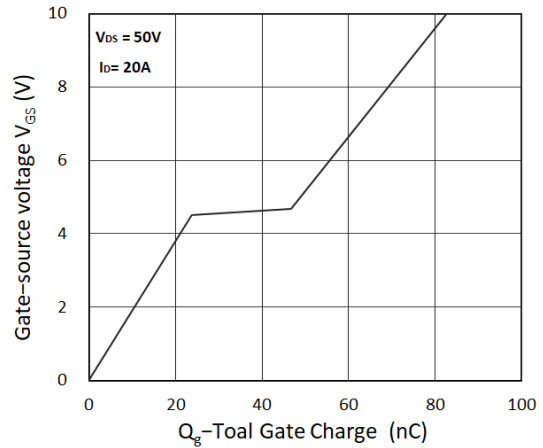

Figure 8. Gate Charge Characteristics

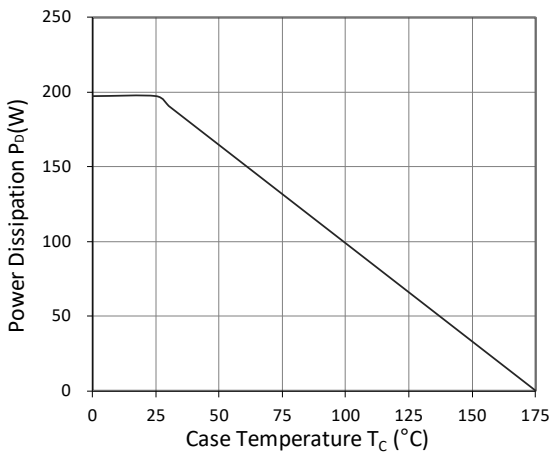

Figure 9. Power Dissipation

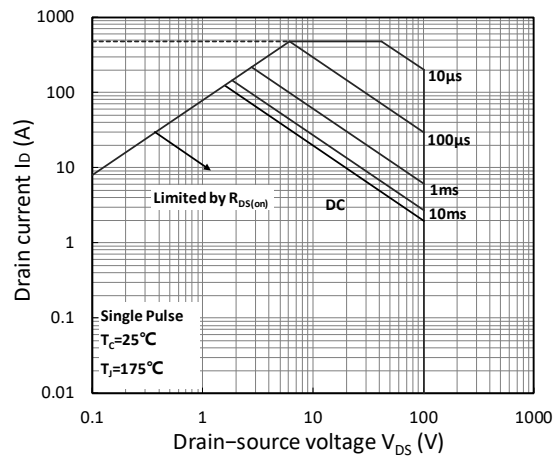

Figure 10. Safe Operating Area

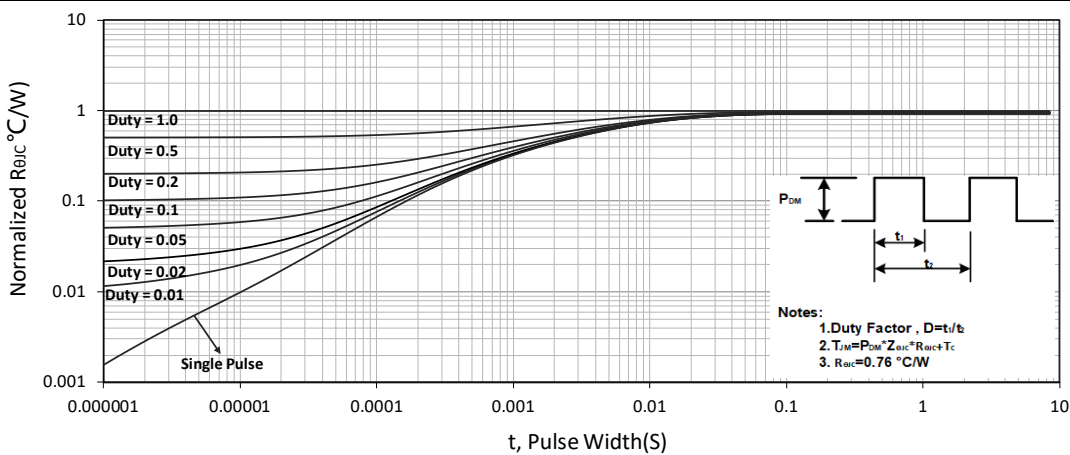

Figure 11. Normalized Maximum Transient Thermal Impedance

Test Circuit

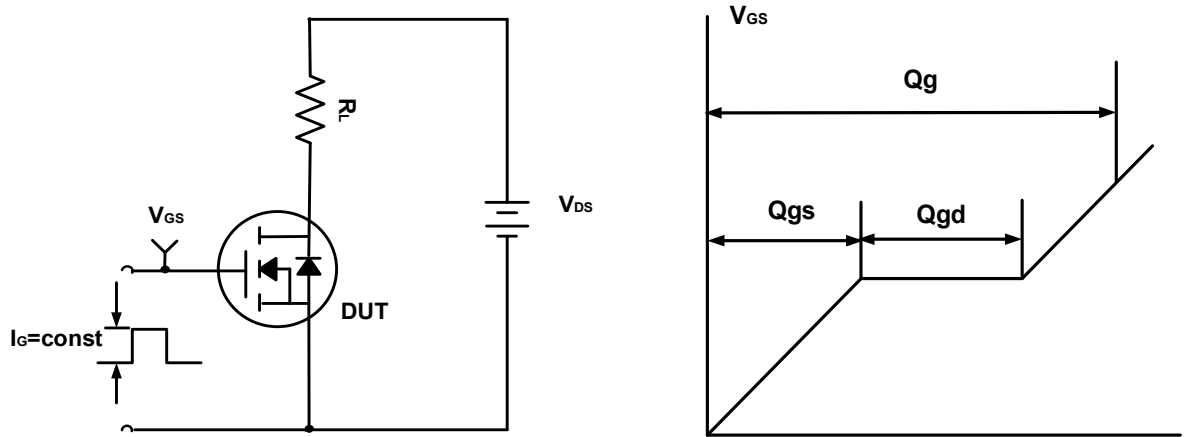

Figure A. Gate Charge Test Circuit & Waveforms

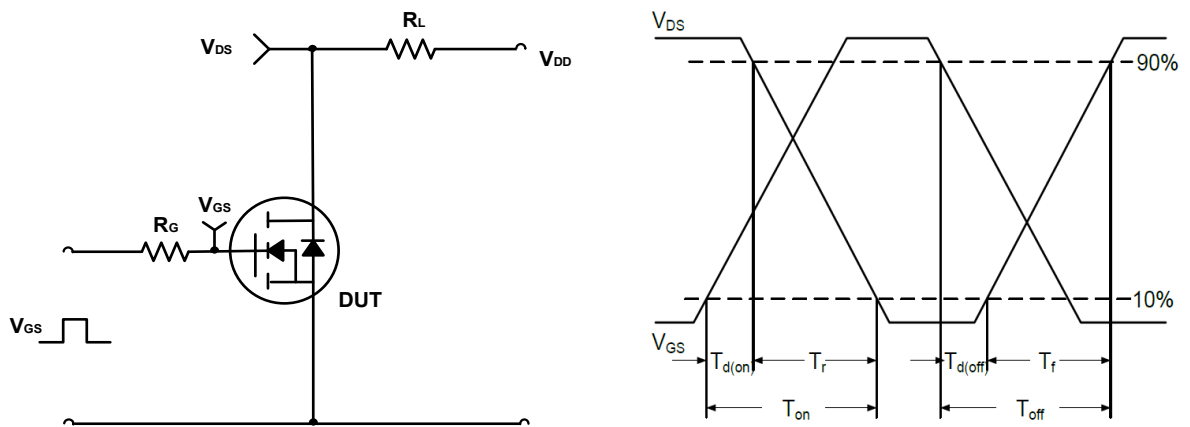

Figure B. Switching Test Circuit & Waveforms

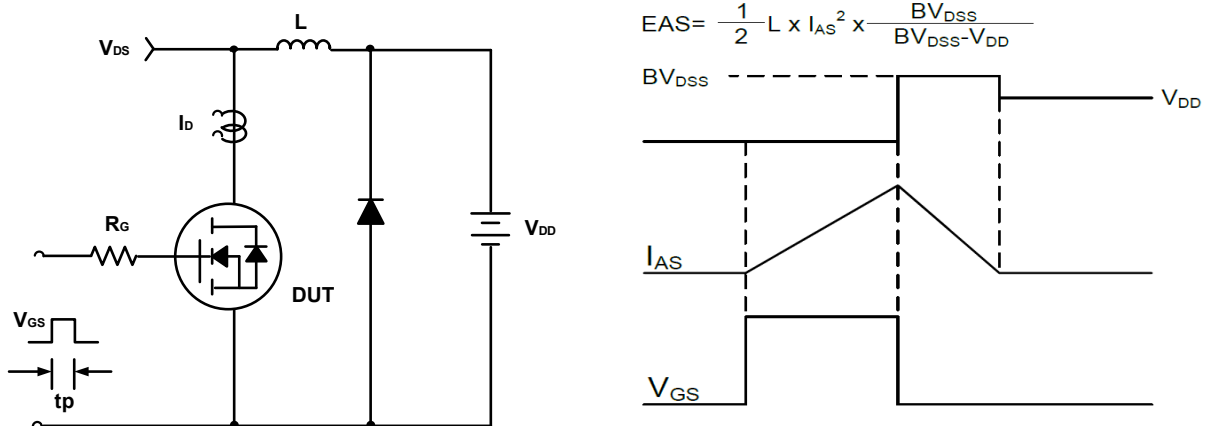
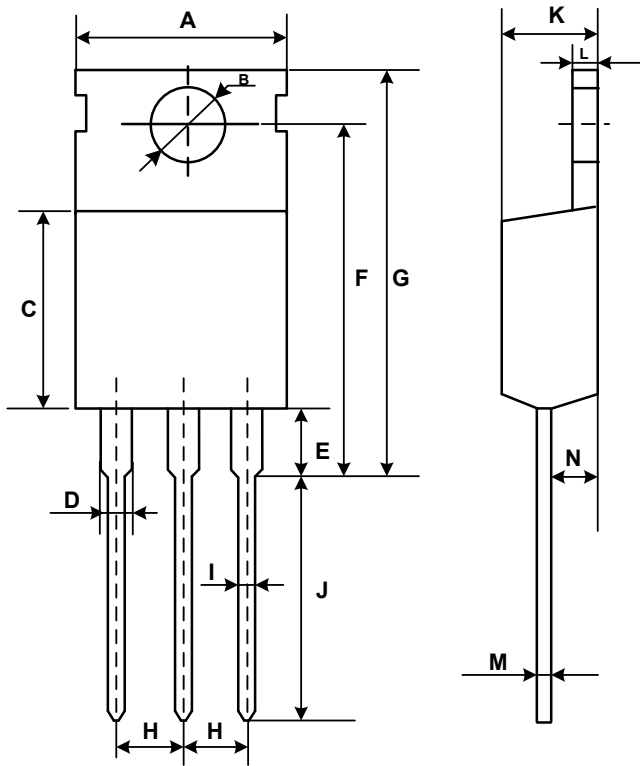

Figure C. Unclamped Inductive Switching Circuit & Waveforms

Mechanical Dimensions for TO-220



COMMON DIMENSIONS

SYMBOL	MM	
	MIN	MAX
A	9.70	10.30
B	3.40	3.80
C	8.80	9.40
D	1.17	1.47
E	2.60	3.50
F	15.10	16.70
G	19.55MAX	
H	2.54REF	
I	0.70	0.95
J	9.35	11.00
K	4.30	4.77
L	1.20	1.45
M	0.40	0.65
N	2.20	2.60

WMK053N10HGS

Ordering Information

Part	Package	Marking	Packing method
WMK053N10HGS	TO-220	WMK053N10HGS	Tube

Marking Information

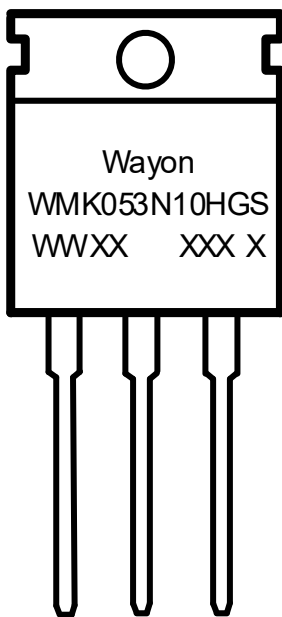

WMK053N10HGS = Device code

WWXX XXX X= Date code